

Linear

# MOMO-R R014

## Fixture Guide

# KKDÖ

Indoor/Outdoor | Recessed | Output up to 1152lm/m (351lm/ft)



### Key applications

- ✓ Bathrooms
- ✓ Ceiling
- ✓ Direct lighting
- ✓ Downlighting
- ✓ Exterior
- ✓ Interior
- ✓ Wall grazing
- ✓ Wallwashing
- ✓ Wet area

### Key features

- ✓ Bathrooms
- ✓ Ceiling
- ✓ Direct lighting
- ✓ Downlighting
- ✓ Exterior
- ✓ Interior
- ✓ Wall grazing
- ✓ Wallwashing
- ✓ Wet area

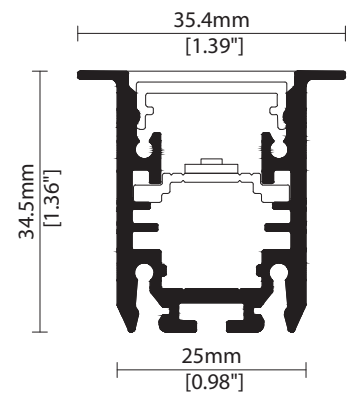

### MOUNTING METHODS



KKSB-01 Spring bracket

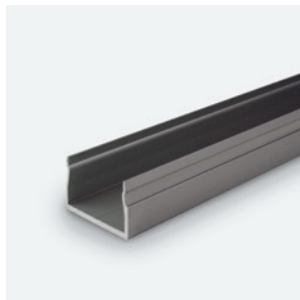

KPCR-01-1000 Cable raceway (1000mm)  
KPCR-01-2000 Cable raceway (2000mm)  
KPCR-01-3000 Cable raceway (3000mm)

Linear

# MOMO-R R014

## Specification sheet



<b>Dimensions</b>	H34.5/W35.4/L108-2025mm* (H1.36/W1.39/L4.25-79.72in*) *KKLN-A2 = 1025mm/40.35in max
<b>PCB Cut-point</b>	41.7mm increment/2000mm* max (1.64in increment/78.74in max*) *KKLN-A2 = 1000mm/39.37in max
<b>LED Pitch</b>	6.95mm-144LED/m (0.27in - 44LED/ft)
<b>Chip</b>	<b>s-line</b> <b>k-line</b>
<b>Cover/Optics</b>	Clear (100°)/Clear + Micro louvre/Clear + KKLN-01 lens (18°)/Clear + KKLN-01 lens (18°) + Micro louvre/Clear + KKLN-03 lens (23°)/Clear + KKLN-03 lens (23°) + Micro louvre/Clear + KKLN-02 Asymmetric lens (Beam tilt 15°, Beam angle 45°)/Diffused (95°)
<b>CCT</b>	<b>s-line:</b> 1900K/2100K/2300K/2500K/2700K/3000K/3500K/4000K/5000K Single colours: Red/Green/Blue/Orange/Amber <b>k-line:</b> 1900K/2100K/2300K/2500K/2700K/3000K/3500K/4000K/5000K
<b>LED binning</b>	<b>s-line:</b> 2-step MacAdam ellipse <b>k-line:</b> 3-step MacAdam ellipse
<b>CRI</b>	≥92
<b>Lifetime</b>	50,000 hours @ 25°C (50,000 hours @ 77°F)
<b>Operating temp</b>	T <sub>a</sub> = -25 to 50°C (T <sub>c</sub> max = 77.9°C) T <sub>a</sub> = -13 to 122°F (T <sub>c</sub> max = 172°F)
<b>IP Rating</b>	IP44/67
<b>Finish</b>	Silver anodised
<b>Mounting</b>	Recessed mounting via spring clip/Cable race way
<b>Power feed</b>	Sheathed hardwire tails or male/female connectors
<b>Control</b>	0-10V/1-10V/DMX/DALI



### LED Grading Key

#### Exclusive Grade

<b>s</b> s-line*	*KKDC tuned CCT range
2-step CCT range	

#### Base Grade

<b>k</b> k-line	3-step commercial range Energy Star CCTs
-----------------	---

<b>Power consumption</b>	<b>Supply voltage</b>	<b>Supply current</b>
14W/m (4.27W/ft)	24V DC	0.58A/m (0.18A/ft)

### Performance Data (3000K)

	R1	R2	R3	R4	R5	R6	R7	R8	R9	R10	R11	R12	R13	R14
<b>k-line</b>	93	96	97	91	92	94	92	83	63	91	91	74	94	98
	<b>Clear</b>	<b>Clear + Micro Louvre</b>	<b>Clear + KKLN-01 (18°)</b>	<b>Clear + KKLN-01 (18°) + Micro Louvre</b>	<b>Clear + KKLN-03 (23°)</b>	<b>Clear + KKLN-03 (23°) + Micro Louvre</b>	<b>Clear + KKLN-A2 Asymmetric lens</b>	<b>Diffused Cover</b>	<b>CRI</b>	<b>R9</b>	<b>Rf</b>	<b>Rg</b>		
<b>s-line</b>	1152lm/m (351lm/ft) 82.3lm/W	342lm/m (104lm/ft) 24.4lm/w	640lm/m (195lm/ft) 45.7lm/W	285lm/m (87lm/ft) 20.4lm/W	663lm/m (202lm/ft) 47.4lm/W	378lm/m (115lm/ft) 27lm/W	1150lm/m (351lm/ft) 82.2lm/W	519lm/m (158lm/ft) 37.1lm/W	93	64	-	-		
<b>k-line</b>	1086lm/m (331lm/ft) 77.6lm/W	323lm/m (98lm/ft) 23.1lm/w	603lm/m (184lm/ft) 43.1lm/W	269lm/m (82lm/ft) 19.2lm/W	626lm/m (191lm/ft) 44.7lm/W	357lm/m (109lm/ft) 25.5lm/W	1085lm/m (331lm/ft) 77.5lm/W	490lm/m (149lm/ft) 35lm/W	92	63	-	-		

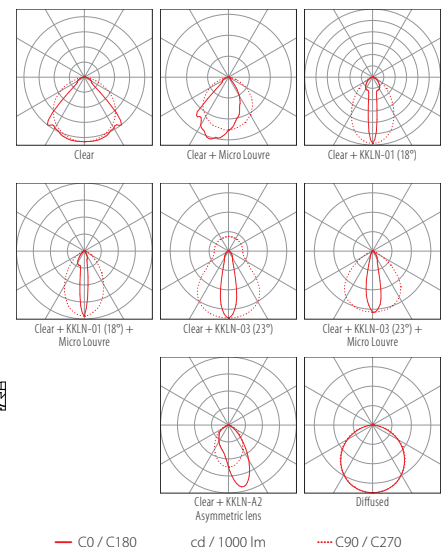
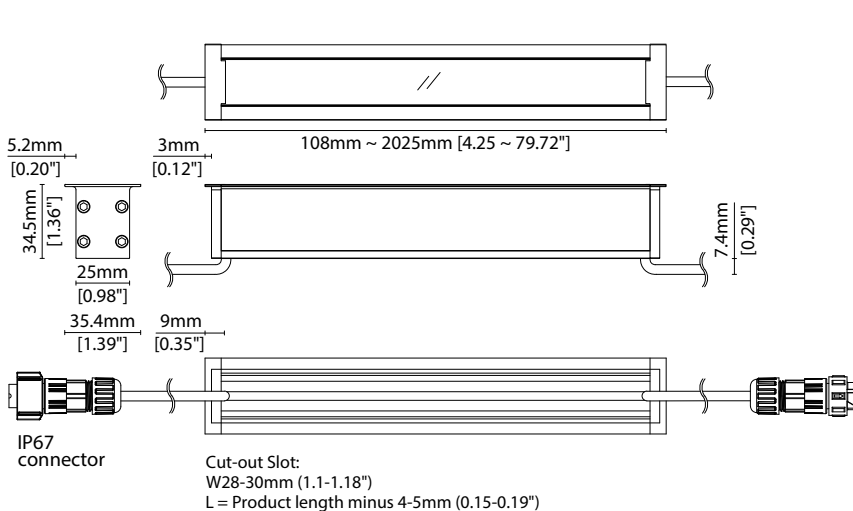

Data derived from production samples tested to UKAS/IESNA LM-79-08 standards.

# MOMO-R R014

## Code Table



### FIXTURE

Model	Finish	Cover/Lens <sup>1</sup>	Grade <sup>2</sup>	LED	Colour (CCT)	Length Availability <sup>3</sup>	IP	Cable Length	Power Feed <sup>4</sup>	Input		
MOMO-R	OR Silver Anodised	SA Clear	B	s	R014 R014	1900K 19	m 108-2025mm 41.7mm increments	IP44 44	300mm/ 11.81"	Single ø4.3mm sheath tail	S00A DC 24V	
			K	k	2100K 21	i 4.26-79.72in 1.64in increments  (Specify length code OR total run length)	IP67 <sup>5</sup> 67	Double ø4.3mm sheath tail				D00A
			P		2300K 23							
					2500K 25							
					2700K 27							
					3000K 30							
					3500K 35							
					4000K 40							
					5000K 50							
					RED RED s only							
					GREEN GRN							
					BLUE BLU							
		ORANGE ORN										
		AMBER AMB										
		U Clear + KKLN-01 (18°)										
		A Clear + KKLN-03 (23°)										
		AK Clear + KKLN-03 (23°) + Micro Louvre										
		BA2 Clear + KKLN-A2										
		C Diffused										

<sup>1</sup> Refer to **Cover/Lens Options** on **Options** pages    <sup>2</sup> Refer to **LED Grading Key** on **Specification sheet** page    <sup>3</sup> Refer to **Length Availability List** or enter total run length instead of length code

<sup>4</sup> Refer to **Power Feed Options** on **Options** pages    <sup>5</sup> Due to the clear, flush potted polyurethane top layer on IP67 MOMO-R a colour shift of +/- 20K should be expected

### Code Example:

OR	-	SA	-	C	-	s	-	R014	-	35	-	m	-	525	-	67	-	0300	-	D67A	-	g
MOMO-R		Silver Anodised		Diffused		s		R014		3500K		525mm		IP67		300mm/11.81"		Double ø4.3mm sheath IP67 connector		DC 24V		

### ACCESSORIES

#### Mounting Accessories

KKSB-01	Spring bracket
KKCR-01-1000	1000mm/39.37" Cable Raceway
KKCR-01-2000	2000mm/78.74" Cable Raceway
KKCR-01-3000	3000mm/118.11" Cable Raceway

\* Refer to **Mounting accessories** on **Accessories** pages

#### Connection Accessories

CN67-2P-0300	IP67 2 PIN male & female 300mm/11.81" pair
CN67-2P-1000	IP67 2 PIN male & female 1000mm/39.37" pair
CN67-2P-3000	IP67 2 PIN male & female 3000mm/118.11" pair

\* Refer to **Power feed** on **Accessories** pages

#### Exterior Junction Boxes

KKJB-07	IP67 Slim J-Box
KKJB-07R	Potting Resin for IP67 Slim J-Box

\* Refer to **Exterior Junction Boxes** on **Accessories** pages

#### PSU/Driver

0-10V/1-10V/DALI/DMX

\* Refer to **Driver/PSU Options** page for details or provide requirement and KKDC to offer the suitable option

### LED ENGINE VARIANTS (LED STRIP TYPE)

Colour	LED	Lumen/m	Lumen/ft	W/m	W/ft	Spec Doc	Length	Increment
Single CCT	R007	563	172	7	2.13	MOMO-R R007	108-2025mm (4.25-79.72in)	41.7mm (1.64in)
	R014	1152	351	14	4.27	MOMO-R R014	108-2025mm (4.25-79.72in)	41.7mm (1.64in)
Warm Dim/Dynamic White	R020	1632	498	20	6.10	MOMO-R R020	108-2025mm (4.25-79.72in)	41.7mm (1.64in)
	R030	2309	704	30	9.14	MOMO-R R030	108-2025mm (4.25-79.72in)	41.7mm (1.64in)
	A040	3668	1118	40	12.19	MOMO-R A040	102-1525mm (4.01-60.03in)	38.46mm (1.51in)
	R207	1282	391	16	4.88	MOMO-R R207	108-2025mm (4.25-79.72in)	83.3mm (3.28in)
RGB	501	Red 125	Red 38	15.6	4.75	MOMO-R RGB	108-2025mm (4.25-79.72in)	83.3mm (3.28in)
		Green 266	Green 81					
		Blue 42	Blue 13					
		RGB 383	RGB 117					
RGBW	R201	973	297	20	6.1	MOMO-R RGBW	160-2035mm (6.30-80.12in)	62.5mm (2.46in)

\* Performance data: A/s-line, clear cover, 3000K

# MOMO-R R014

## Length Availability List



Length Code		Fixture Length <sup>1</sup>		LED Strip <sup>2</sup>		End Cap Dimension <sup>3</sup>		Wattage (W)	Output (lm)
Metric	Imperial(US)	Metric	Imperial(US)	Metric	Imperial(US)	Metric	Imperial(US)		3000K (Test Data)
m0108	i0004	108mm	4.27in	83mm	3.28in	15mm	0.59in	1.17	91
m0150	i0006	150mm	5.91in	125mm	4.92in	15mm	0.59in	1.75	136
m0192	i0008	192mm	7.55in	167mm	6.56in	15mm	0.59in	2.33	181
m0233	i0009	233mm	9.19in	208mm	8.20in	15mm	0.59in	2.92	226
m0275	i0011	275mm	10.83in	250mm	9.84in	15mm	0.59in	3.50	272
m0317	i0012	317mm	12.47in	292mm	11.48in	15mm	0.59in	4.08	317
m0358	i0014	358mm	14.11in	333mm	13.12in	15mm	0.59in	4.67	362
m0400	i0016	400mm	15.75in	375mm	14.76in	15mm	0.59in	5.25	407
m0442	i0017	442mm	17.39in	417mm	16.40in	15mm	0.59in	5.83	453
m0483	i0019	483mm	19.03in	458mm	18.04in	15mm	0.59in	6.42	498
m0525	i0021	525mm	20.67in	500mm	19.69in	15mm	0.59in	7.00	543
m0567	i0022	567mm	22.31in	542mm	21.33in	15mm	0.59in	7.58	588
m0608	i0024	608mm	23.95in	583mm	22.97in	15mm	0.59in	8.17	634
m0650	i0026	650mm	25.59in	625mm	24.61in	15mm	0.59in	8.75	679
m0692	i0027	692mm	27.23in	667mm	26.25in	15mm	0.59in	9.33	724
m0733	i0029	733mm	28.87in	708mm	27.89in	15mm	0.59in	9.92	770
m0775	i0031	775mm	30.51in	750mm	29.53in	15mm	0.59in	10.50	815
m0817	i0032	817mm	32.15in	792mm	31.17in	15mm	0.59in	11.08	860
m0858	i0034	858mm	33.79in	833mm	32.81in	15mm	0.59in	11.67	905
m0900	i0035	900mm	35.43in	875mm	34.45in	15mm	0.59in	12.25	951
m0942	i0037	942mm	37.07in	917mm	36.09in	15mm	0.59in	12.83	996
m0983	i0039	983mm	38.71in	958mm	37.73in	15mm	0.59in	13.42	1041
m1025	i0040	1025mm	40.35in	1000mm	39.37in	15mm	0.59in	14.00	1086
m1067	i0042	1067mm	41.99in	1042mm	41.01in	15mm	0.59in	14.58	1132
m1108	i0044	1108mm	43.64in	1083mm	42.65in	15mm	0.59in	15.17	1177
m1150	i0045	1150mm	45.28in	1125mm	44.29in	15mm	0.59in	15.75	1222
m1192	i0047	1192mm	46.92in	1167mm	45.93in	15mm	0.59in	16.33	1267
m1233	i0049	1233mm	48.56in	1208mm	47.57in	15mm	0.59in	16.92	1313
m1275	i0050	1275mm	50.20in	1250mm	49.21in	15mm	0.59in	17.50	1358
m1317	i0052	1317mm	51.84in	1292mm	50.85in	15mm	0.59in	18.08	1403
m1358	i0053	1358mm	53.48in	1333mm	52.49in	15mm	0.59in	18.67	1449
m1400	i0055	1400mm	55.12in	1375mm	54.13in	15mm	0.59in	19.25	1494
m1442	i0057	1442mm	56.76in	1417mm	55.77in	15mm	0.59in	19.83	1539
m1483	i0058	1483mm	58.40in	1458mm	57.41in	15mm	0.59in	20.42	1584
m1525	i0060	1525mm	60.04in	1500mm	59.06in	15mm	0.59in	21.00	1630
m1567	i0062	1567mm	61.68in	1542mm	60.70in	15mm	0.59in	21.58	1675
m1608	i0063	1608mm	63.32in	1583mm	62.34in	15mm	0.59in	22.17	1720
m1650	i0065	1650mm	64.96in	1625mm	63.98in	15mm	0.59in	22.75	1765
m1692	i0067	1692mm	66.60in	1667mm	65.62in	15mm	0.59in	23.33	1811
m1733	i0068	1733mm	68.24in	1708mm	67.26in	15mm	0.59in	23.92	1856
m1775	i0070	1775mm	69.88in	1750mm	68.90in	15mm	0.59in	24.50	1901
m1817	i0072	1817mm	71.52in	1792mm	70.54in	15mm	0.59in	25.08	1946
m1858	i0073	1858mm	73.16in	1833mm	72.18in	15mm	0.59in	25.67	1992

# MOMO-R R014

## Length Availability List



Length Code		Fixture Length <sup>1</sup>		LED Strip <sup>2</sup>		End Cap Dimension <sup>3</sup>		Wattage (W)	Output (lm)
Metric	Imperial(US)	Metric	Imperial(US)	Metric	Imperial(US)	Metric	Imperial(US)		3000K (Test Data)
m1900	i0075	1900mm	74.80in	1875mm	73.82in	15mm	0.59in	26.25	2037
m1942	i0076	1942mm	76.44in	1917mm	75.46in	15mm	0.59in	26.83	2082
m1983	i0078	1983mm	78.08in	1958mm	77.10in	15mm	0.59in	27.42	2128
m2025	i0080	2025mm	79.72in	2000mm	78.74in	15mm	0.59in	28.00	2173

<sup>1</sup> Actual total overall length of light fixture (LED strip + end caps + void/wire hole)

<sup>2</sup> Actual length of PCB strip

<sup>3</sup> Actual length of 2x end caps

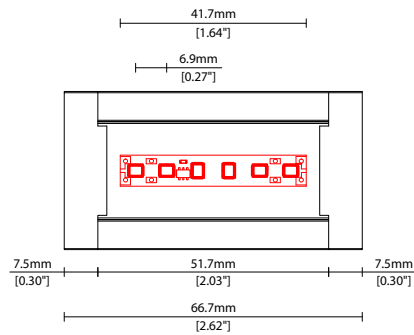

CUT-OUT SLOT:

W28-30mm (1.1-1.18")

L = Product length minus 4-5mm (0.15-0.19")

### COVER/LENS OPTIONS

\* Options are an integral part of the fixture ordering codes. Please refer to **Code Table** pages.

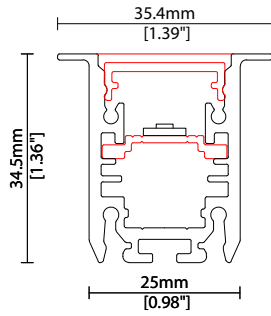
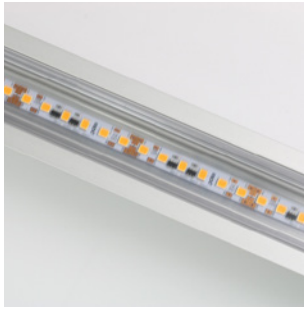

**B** Clear Cover  
W25.0/H34.5mm (W0.98/H1.36")

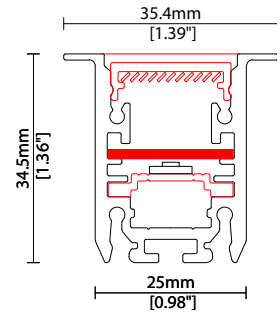

**K** Clear Cover + Micro Louvre  
W25.0/H34.5mm (W0.98/H1.36")

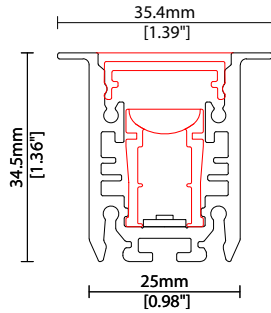
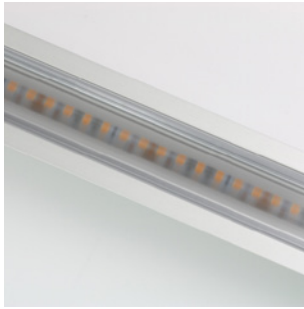

**P** Clear + KKLN-01 (18°)  
W25.0/H34.5mm (W0.98/H1.36")

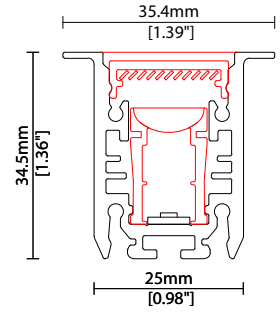
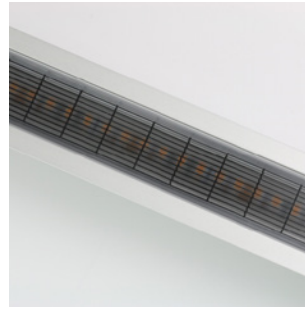

**U** Clear + KKLN-01 (18°)  
+ Micro Louvre  
W25.0/H34.5mm (W0.98/H1.36")

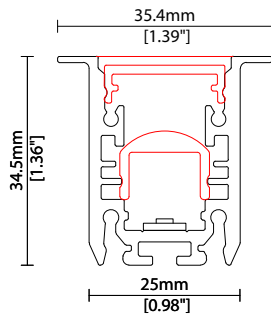

**A** Clear + KKLN-03 (23°)  
W25.0/H34.5mm (W0.98/H1.36")

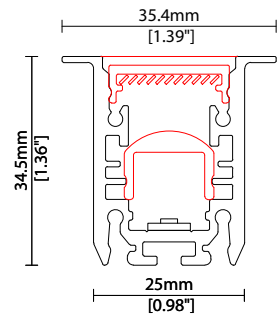

**AK** Clear + KKLN-03 (23°)  
+ Micro Louvre  
W25.0/H34.5mm (W0.98/H1.36")

Linear

# MOMO-R R014

## Options

# KKDC

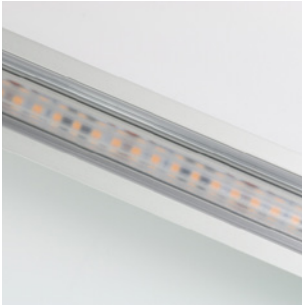

**BA2** Clear + KKLN-A2

W25.0/H34.5mm (W0.98/H1.36")

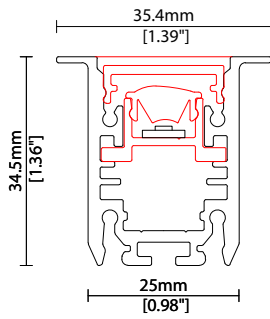

**C** Diffused

W25.0/H34.5mm (W0.98/H1.36")

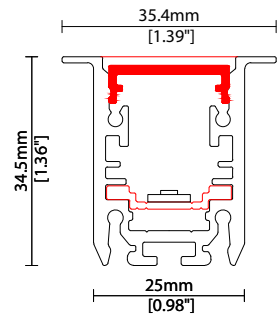

### POWER FEED OPTIONS

0300 S00A 300mm (11.81") Single Ø4.3mm sheath tail

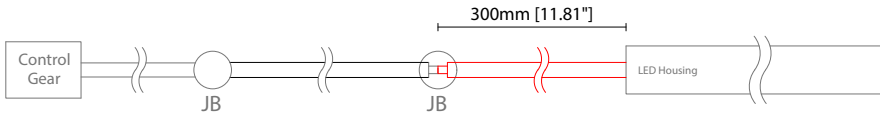

0300 D00A 300mm (11.81") Double Ø4.3mm sheath tail

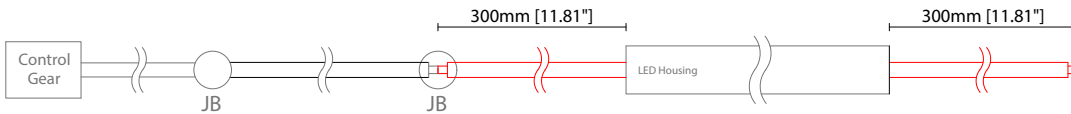

0300 S67A 300mm (11.81") Single ø4.3mm sheath IP67 connector

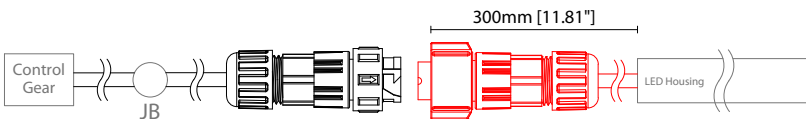

0300 D67A 300mm (11.81") Double ø4.3mm sheath IP67 connector

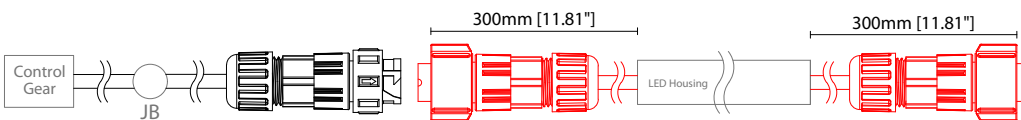

### IP67 2 Pin Connector

Female connector  
2 PIN (IP67)

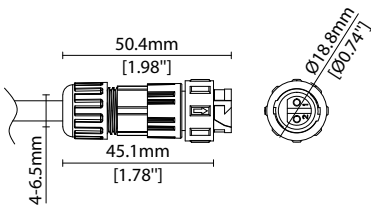

Male connector  
2 PIN (IP67)

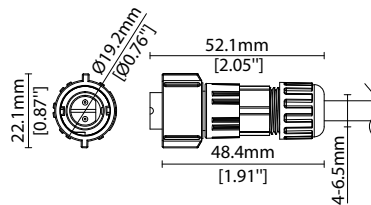

### Key

Control Gear Power supply, sub-controllers & control systems  
 JB Junction box / cable connection



### MOUNTING ACCESSORIES

Note: Accessories are to be ordered separately with corresponding code shown below.

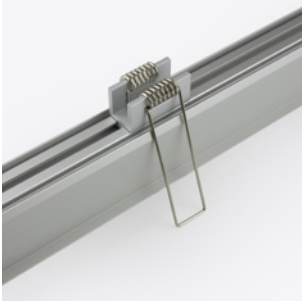

#### KKS-01

Spring bracket  
(allow 2 per metre/40")  
Anodised aluminium finish  
L31/W35.4/H45.2mm  
(L1.22/W1.39/H1.78")

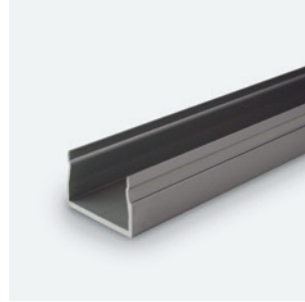
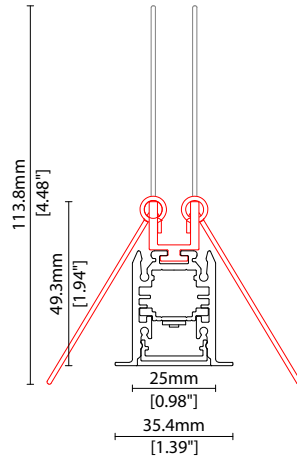

KKCR-01-1000	1000mm (39.37in)
KKCR-01-2000	2000mm (78.74in)
KKCR-01-3000	3000mm (118.11in)

Cable raceway\*  
anodised aluminium finish  
W22/H36.4mm (W0.87/H1.43")

\* Cut & drilled to fit on site

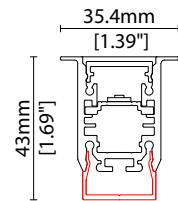

### POWER FEED

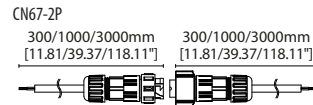

CN67-2P-0300	300mm (11.81in) pair
CN67-2P-1000	1000mm (39.37in) pair
CN67-2P-3000	3000mm (118.11in) pair

IP67

2 PIN male + female connector set

### EXTERIOR JUNCTION BOXES



**KKJB-07**

IP67 Slim J-Box  
(including type A,B,C,D bushings)



**KKJB-07R**

Potting resin for IP67 Slim J-Box

### KKDC CONTROL



**KKDM-06** 1-10V

visDIM dimmable sub-controller  
(4 x 8A max @ 12-36V)

IP20  
Plastic housing  
L170/W59/H29mm  
(L6.69/W2.32/H1.14in)



**KKSC-05** DMX

visDIM dimmable sub-controller  
(4 x 5A max @ 12-36V)

IP20  
Plastic housing  
L170/W53.4/H28mm  
(L6.69/W2.10/H1.10in)



**KKDL-02** DALI

visDIM dimmable sub-controller  
(4 x 8A max @ 12-36V)

IP20  
Plastic housing  
L170/W59/H29mm  
(L6.69/W2.32/H1.14in)



**KKDL-03** DALI

visDIM dimmable sub-controller  
(4 x 5A max @ 12-36V)

IP20  
Plastic housing  
L166/W53.4/H23mm  
(L6.54/W2.10/H0.91in)

### AVAILABLE PSU OPTIONS

Control Mode	PSU (Order Code)	Input Voltage AC	Output Voltage DC	Rated Output Current	Rated Power	Dim %	IP Rating
Switched	CEN-60-24	90-295V	24V	2.5A	60W	-	IP67
	HLG-60H-24	90-305V	24V	2.5A	60W	-	IP67
	HLG-100H-24	90-305V	24V	4.0A	100W	-	IP67
	HLG-150H-24	90-305V	24V	6.3A	150W	-	IP67
	HLG-240H-24	90-305V	24V	10A	240W	-	IP67
0-10V (1-10V)	PWM-40-24	90-305V	24V	1.67A	40W	100-0.15 (100-10)	IP67
	PWM-60-24	90-305V	24V	2.5A	60W	100-0.15 (100-10)	IP67
	PWM-90-24	90-305V	24V	3.67A	90W	100-0.15 (100-10)	IP67
	PWM-120-24	90-305V	24V	5.0A	120W	100-0.15 (100-10)	IP67
DALI	LIN100A1	120-277V	24V	1A per channel	100W	100-0.1	IP66/IP40
DMX RGB	LIN100A1	120-277V	24V	1.33A per channel	100W	100-0.1	IP66/IP40
DMX RGBW	LIN100A1	120-277A	24V	1A per channel	100W	100-0.1	IP66/IP40

### Flicker Free Options - Combination of PSU+ sub-controller

Control Mode	PSU (Order Code)	Sub-controller (Order Code)	Input Voltage AC	Output Voltage DC	Rated Output Current	Rated Power	Dim %	IP Rating PSU/ Sub-controller
0-10V or 1-10V	CEN-60-24	KKDM-06	90-295V	24V	2.5A	60W	100-0.9	IP67/IP20
	HLG-60H-24	KKDM-06	90-295V	24V	2.5A	60W	100-0.9	IP67/IP20
	HLG-100H-24	KKDM-06	90-295V	24V	4.0A	100W	100-0.9	IP67/IP20
	HLG-150H-24	KKDM-06	90-295V	24V	6.3A	150W	100-0.9	IP67/IP20
	HLG-240H-24	KKDM-06	90-295V	24V	10.0A	240W	100-0.9	IP67/IP20
DALI	CEN-60-24	KKDL-02/03	90-295V	24V	2.5A	60W	100-0.1	IP67/IP20
	HLG-60H-24	KKDL-02/03	90-305V	24V	2.5A	60W	100-0.1	IP67/IP20
	HLG-100H-24	KKDL-02/03	90-305V	24V	4.0A	100W	100-0.1	IP67/IP20
	HLG-150H-24	KKDL-02/03	90-305V	24V	6.3A	150W	100-0.1	IP67/IP20
	HLG-240H-24	KKDL-02/03	90-305V	24V	10.0A	240W	100-0.1	IP67/IP20
DMX RGB	CEN-60-24	KKSC-05	90-295V	24V	2.5A	60W	100-0.9	IP67/IP20
	HLG-60H-24	KKSC-05	90-305V	24V	2.5A	60W	100-0.9	IP67/IP20
	HLG-100H-24	KKSC-05	90-305V	24V	4A	100W	100-0.9	IP67/IP20
	HLG-150H-24	KKSC-05	90-305V	24V	6.3A	150W	100-0.9	IP67/IP20
	HLG-240H-24	KKSC-05	90-305V	24V	10.0A	240W	100-0.9	IP67/IP20

<sup>1</sup> The items shown above cover the most frequently used specification but does not exhaust the possible options

<sup>2</sup> PSU and/or driver can be chosen from the table, or KKDC may recommend the best option upon receipt of the controls requirement and installation environment

<sup>3</sup> Electrical shop drawing will include detailed information of PSU and relevant control drivers

<sup>4</sup> Cut sheets are available on the controls section of [www.kkdc.lighting](http://www.kkdc.lighting) or upon request